

Varenummer: 0125054  
 Beskrivelse: Seeger låsering SP37  
 Fjederstål

## Mål

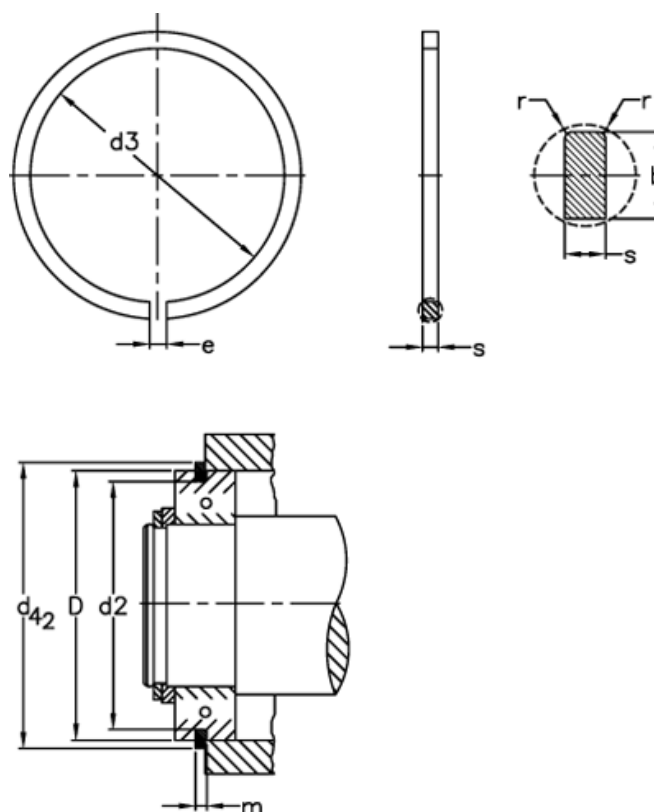

b	= 3.25	FRg kN	= 2.45	tol	= -0.15
Betegnelse	= SP 37	FR kN	= 13.6	tol	= -0.1
D	= 37	g	= 2.0	tol	= -0.25
d2	= 34.77	K kN-mm	= 26.6	tol	= 0.3
d3	= 34.0	m	= 1.35	tol	= 0.4
d42	= 41.3	n abl x 1000	= 10.0	vægt kg/1000	= 3.4
e	= 3	r min	= 0.4		
FN kN	= 20.7	s	= 1.12		